

Translation of the original operating
manual 99988069 Rev. 2.3

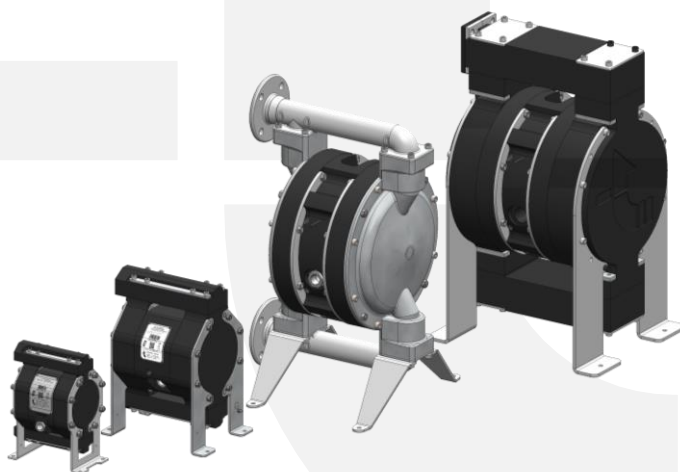

PTI MEM 5060V
PTI MEM 5150V
PTI MEM 5600V



Year of manufacture: 2021

We reserve the right to make technical changes to the presentations and information in this manual that are necessary for improvement of the product characteristics.

All copyrights and protective rights to this product and all associated technical documentation shall remain with the company Timmer GmbH.

This manual is intended for every person who is assigned to perform tasks on and with the pump. It contains instructions and drawings that must not, either in whole or in part, be duplicated, disseminated, used for competitive purposes, or communicated to other persons without authorisation.

All rights reserved.

Copyright 2021 Timmer GmbH

1	Contents	
1	Contents	3
2	EU-declaration of conformity for EX-protected pumps..	6
3	EU-declaration of conformity for non EX-protected pumps.....	7
4	About this manual	8
4.1	Use and safekeeping	8
4.2	Manufacturer information	9
4.3	Areas of applicability	9
4.4	Warranty.....	10
5	Safety	11
5.1	Basic information concerning safety	11
5.2	Compliance with the instructions in the operating manual.....	12
5.3	Operational prerequisites	13
5.4	Intended use	13
5.5	Non-intended use.....	14
5.6	Foreseeable misuse.....	15
5.7	Signage at the pump	15
5.7.1	Type Plate	15
5.7.2	Labelling Connection Sensor (optional).....	16
5.7.3	Warning sign electostatic charge	16
5.8	Qualifications of personnel.....	16
5.9	Personal protective equipment	17
5.10	Safety notices in the operating manual.....	18
5.11	Safety notices.....	19
6	Transport	23
6.1	Check scope of delivery	23
6.2	Lifting pump scope of delivery	23
7	Additional ATEX information	24
7.1	ATEX-marking in accordance with directive RL 2014/34/EU und DIN EN ISO 80079-36 für die Pumpe	24
7.2	Optional Componenten	27
7.2.1	Ignition Sources	27
7.3	Optional ATEX Component.....	28

8	Storage	29
9	Product description	30
9.1	Product description: Pump	31
9.2	Product description: Options	32
9.2.1	Diaphragm fracture identification	32
9.2.2	Emptying of residues	32
10	Installation	33
10.1	Safety notices	33
	Preparations	37
10.2	Pump assembly	37
10.2.1	Connection Options	38
10.2.2	Laying the connection line	39
11	Commissioning	40
11.1	Safety notices	40
12	Operation	43
12.1	Switch on	43
12.2	Regulating the delivery rate	43
12.3	Switch off	43
13	Fault rectification	44
14	Maintenance /Cleaning	45
14.1	Safety notices	45
14.2	General	47
14.3	Maintenance schedule	48
14.4	Tightening torques	49
14.5	Cleaning	50
14.6	Timmer-Service	51
14.7	Replacement of components	51
14.7.1	Replacement and cleaning of the compressed air filter	52
14.7.2	Replacement and cleaning of the membranes and balls	53
15	Decommissioning	55
15.1	Safety notice	55
16	Disposal	57
16.1	Return shipment	57

Contents

17	Technical data diaphragm pump.....	58
17.1	Type Code.....	59
17.2	Material.....	60
18	Spare Parts.....	60
19	Notes	61

2 EU-declaration of conformity for EX-protected pumps

Design: DOUBLE DIAPHRAGM PUMP
Type: PTI-MEM5060V-PE1-...-PE1-... / PTI-MEM5060V-TFE-...-PE1-...
PTI-MEM5150V-PE1-...-PE1-... / PTI-MEM5150V-TFE-...-PE1-...
PTI-MEM5600V-PE1-...-PE1-... / PTI-MEM5600V-TFE-...-PE1-...
PTI-MEM5600V-VA-...-PE1-... / PTI-MEM5600V-AL-...-PE1-...

ATEX marking:  II 2G Ex h IIB T6-T4 Gb X
II 2D Ex h IIIC 85°C-150°C Db X

This double diaphragm pump has been designed and manufactured in accordance with the following EC/EU directives:

Directive 2006/42/EC OJEU L157/24 of 17 May 2006

Directive 2014/34/EU, OJEU L 96/309 of 26 February 2014

under the sole responsibility of (manufacturer):

Timmer GmbH
Dieselstraße 37
D-48485 Neuenkirchen
www.timmer.de

The following harmonised standards have been applied:

EN ISO 12100:2010 Safety of machinery –

General principles of design – Risk assessment and risk reduction

EN 809:1998+A1:2009 Pumps and pump units for liquids – Common safety requirements

EN ISO 4414:2010 Pneumatic fluid power - General rules and safety requirements for systems and their components

DIN EN ISO80079-36:2016: Explosive atmospheres - Part 36: Non-electrical equipment for explosive atmospheres– Basic method and requirements (ISO 80079-36:2016)

DIN EN ISO80079-37:2016: Explosive atmospheres - Part 37: Non-electrical equipment for explosive atmospheres - Non-electrical type of protection constructional safety "c", control of ignition sources "b", liquid immersion "k" (ISO 80079-37:2016)

Person responsible for compiling the documentation: Timmer GmbH

Address: See manufacturer

Commissioning in potentially explosive atmospheres is prohibited until it has been ascertained that the special conditions specified in the installation and operating manual for the intended use in potentially explosive atmospheres have been met. The conformity of the built-in electrical device is confirmed by a separate declaration of conformity.

Neuenkirchen, Nov. 2021

City, Date

Klaus Gehrman (Managing Director)



3 EU-declaration of conformity for non EX-protected pumps

Design: DOUBLE DIAPHRAGM PUMP
Type: PTI-MEM5060V-PE5-...../ PTI-MEM5060V-TF-.....
PTI-MEM5150V-PE5-...../ PTI-MEM5150V-TF-.....
PTI-MEM5600V-PE5-...../ PTI-MEM5600V-TF-.....

ATEX marking: -

This double diaphragm pump has been designed and manufactured in accordance with the following EC/EU directives:

Directive 2006/42/EC OJEU L157/24 of 17 May 2006

under the sole responsibility of (manufacturer):

Timmer GmbH
Dieselstraße 37
D-48485 Neuenkirchen
www.timmer.de

The following harmonised standards have been applied:

- EN ISO 12100:2010 Safety of machinery – General principles of design – Risk assessment and risk reduction
- EN 809:1998+A1:2009 Pumps and pump units for liquids – Common safety requirements
- EN ISO 4414:2010 Pneumatic fluid power - General rules and safety requirements for systems and their components

Person responsible for compiling the documentation: Timmer GmbH
Address: See manufacturer

Neuenkirchen, Nov. 2021
City, Date

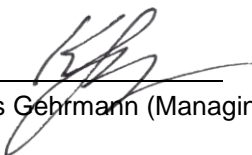
Klaus Gehrman (Managing Director)

4 About this manual

4.1 Use and safekeeping

Please note the following points:

- The pump can only be appropriately and safely commissioned, operated and maintained with the aid of this operating manual.
- This operating manual refers only to the product that is specified on the cover sheet.
- This operating manual is part of the scope of delivery.
- Consequently, always keep this operating manual in legible condition, within easy reach for the operator, in the vicinity of the pump. Keep this document with the pump in the event of resale or rental.
- This operating manual is intended only for instructed and authorised specialists.
- The Safety section provides an overview of all important safety aspects for optimal protection of personnel, and for safe and trouble-free operation of the pump.
- The manufacturer is not liable for damage resulting from failure to comply with the instructions in this operating manual.
- Reprints, translations and duplications in any form, including excerpts, require the written consent of the publisher.
- The copyright remains with the manufacturer.

About this manual

4.2 Manufacturer information

Timmer GmbH

Dieselstrasse 37

48485 Neuenkirchen, Germany

Tel.: +49 5973 9493-0

Fax: +49 5973 9493-90

info@timmer.de

www.timmer.de

4.3 Areas of applicability

This product complies with the directives of the European Union.

In this regard, please note:

- The provided EU Declaration of Conformity
- The intended use
- Non-intended use

4.4 Warranty

For all Timmer pumps, we grant the initial purchaser a one year warranty on workmanship and material, starting from the date of purchase; provided that the pump is used as intended. Normal wear is excluded from the liability. The warranty is automatically null and void, if parts other than original Timmer spare parts are installed in the Timmer pump.

In accordance with applicable law, Timmer GmbH excludes all liability for consequential damages. In all cases the liability of Timmer GmbH shall be restricted to, and in no case shall exceed the equivalent value of the purchase price. Prior to purchase and shipment of the Timmer pump, the customer should review the national and local laws and regulations to ensure that the product, the installation and the application are in compliance with the applicable regulations.

- Notify the manufacturer immediately of warranty claims after defects or faults are detected.
- The information, illustrations and descriptions in this operating manual do not give rise to any claims for changes to systems and components that have already been delivered.
- No liability is accepted for damage or malfunctions that occur as described below:
 - Disregarding the operating manual
 - Unauthorised modifications of the system
 - Operating error
 - Failure to perform maintenance tasks

5 Safety

5.1 Basic information concerning safety

The Safety section provides an overview of all important safety aspects for optimal protection of personnel, as well as for safe and trouble-free use of the pump, from transport to operation and disposal.

Failure to comply with the instructions and safety notices cited in this operating manual can result in considerable hazards for personnel and material damage of the pump.

The pump is operationally reliable.

However more extensive residual hazards can be associated with operation of the pump under the following circumstances, if

- The pump is not used as intended.
- The pump is used improperly or operated by untrained or uninstructed personnel.
- The pump is not properly maintained or serviced.
- The safety instructions, notices and warnings specified in this operating manual are not complied with.
- The pump is improperly modified or converted.
- The prescribed maintenance is not performed in a timely manner.
- In case of a diaphragm fracture the conveyed medium can escape from the silencer. It can lead by a longer operating of the damaged pump that the medium escapes out from the pump. The operator must take organizational and constructive actions to ensure that there is no danger from escaping hazardous liquids.

5.2 Compliance with the instructions in the operating manual

Every person who is assigned to perform tasks on and with the pump must have read and understood this operating manual, particularly the "Safety" section.

Knowledge of and compliance with the content of this manual is the prerequisite for protecting personnel from danger and avoiding errors.

Therefore, all safety notices and safety instructions must be strictly complied with.

Compliance is for your own safety.

The operating manual is a component of the pump and must always be available in the vicinity of the product. The operating manual must be complied with. If the content of this operating manual leaves any questions unanswered or is not understandable, contact the manufacturer immediately – see the "Manufacturer information" section.

In addition to the safety instructions in this operating manual the following rules and regulations must also be complied with:

- Intended use
- The national and company-internal accident prevention regulations (UVV)
- Occupational health regulations
- Generally accepted rules for safety
- Country-specific regulations
- Manufacturer information (safety data sheets) for operating materials and auxiliary materials, chemical substances

Moreover, these rules and regulations can be supplemented with work instructions that take into account plant-internal regulations or operational particularities.

In supplementation to this operating manual, company-internal instruction with due consideration of the technical qualifications of the respective persons must also be provided.

5.3 Operational prerequisites

Dependence on other installations and equipment must be tested by the owner separately.

Moreover, the following prerequisites must be met for regular operation of the pump, unless they are within our area of responsibility:

- Properly concluded installation
- Successful trial run with all required adjustment tasks
- Instruction of operating personnel concerning operation of the pump and the national safety regulations and the company's own safety regulations
- If hot or cold machine parts result in additional danger, then the customer must provide guards that prevent these parts from being touched
- The possibility of hazards due to electrical energy must be excluded (for details in this regard see VDE guidelines or guidelines issued by the electrical utility, for example)
- The pump must be easily accessible
- Determination of a person who is primarily responsible for proper operation
- Attention and adherence of the operating manual to the third-party manufacturer.

5.4 Intended use

- The pump and the operating manual are intended exclusively for commercial use.
- The pump must only be used for pumping fluid media (see section "Technical data").
- The pump must only be operated within the limits specified for intended use (see section "Technical data").
- The pumped medium must be compatible with the materials of the pump (see section "Technical data").
- The owner of the pump is responsible for selection of the medium to be pumped.
- The pump must only be operated in environments that do not adversely affect the properties of the materials used.
It is the responsibility of the owner to verify the suitability of the material.
- The pump should only be used in environments which it is impossible that solar radiation, UV or thermal radiation or other high-energy radiation will negatively affect the characteristic of the plastic.

5.5 Non-intended use

A use other than the use described in the section, "Intended use" and in this operating manual, and any use that extends beyond the specified intended use, is considered non-intended use. The manufacturer shall not be liable for damage resulting from non-intended use. This risk is borne solely by the user / owner.

- Pumping of media that does not meet the product specification
- Do not modify the pump in any manner whatsoever.
- Use of the pump for purposes other than those cited in section 5.4
- Operating a damaged pump
- Operation, maintenance and repair of the system by unauthorised and/or untrained personnel
- Pump operation without earthing
- Pump operation outside of the specified parameters and/or operating data
- Operating the pump at a location where there are ignition hazards due to sources of ignition in the vicinity of the pump
- Use or commissioning of the pump by private users
- Modifying or converting the pump
- Set up on unsuitable substrates
- Attaching transport aids on the housing
- Failure to comply with the specified maintenance intervals
- Operating the pump in Zone 0 explosive gas/dust atmospheres
- Immersing the pump in the pumped medium
- Operation in explosive atmospheres without prior implementation of the requirements stipulated in Directive 1999/92/EC and national regulations for explosion protection, on the part of the owner
- Initial commissioning without prior inspection of the area and the pump by a person qualified to perform the inspection
- Pumping of media that is chemically incompatible with the materials used to construct the pump – The owner of the pump must check the chemical compatibility of the pumped media
- Pumping of media with parameters (e.g. ignition temperatures) that are not compatible with the information specified on the pump
- The conveying of non-conductive media without additional protective measures (see chap.7.1)

5.6 Foreseeable misuse

The following points describe foreseeable misuse of the pump:

- Set up on unsuitable substrates
- Attachment of transport aids on the housing
- Failure to comply with the operating data
- Failure to follow the maintenance schedule
- Operation with unsuitable media
- Operation in the wrong Ex zone

5.7 Signage at the pump

The nameplate attached on the pump must be strongly observed. It must not be removed and must be kept in a completely legible condition.

5.7.1 Type Plate

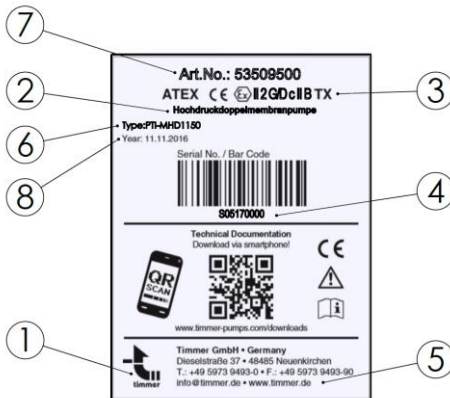



Fig. 1: Type plate

- | | | | |
|---|---|---|----------------------|
| 1 | Logo | 5 | manufacturer address |
| 2 | Product designation | 6 | Type Key |
| 3 | ATEX marking in accordance with RL 2014/34/EU | 7 | Item Number |
| 4 | Serial number | 8 | Date |

5.7.2 Labelling Connection Sensor (optional)

<p>Achtung! Eigensicheres Betriebsmittel. Nur zugehörige Betriebsmittel verwenden.</p> <p>Warning! Intrinsically safe device. Only use with associated equipment.</p> <p> II 2G/D</p> <p>Ex ib IIC T4 Gb</p> <p>Ex ib IIIC T135°C Db</p> <p>-25°C ≤ Ta ≤ +70°C</p> <p>TYP: 53507437</p>	<p>Marking of the connection of the electrical sub-unit.</p> <p>When using the optional magnetic proximity sensor, the following marking is additionally carried out on pumps for the explosion area at the connection of the sensor.</p>
--	---

5.7.3 Warning sign electrostatic charge

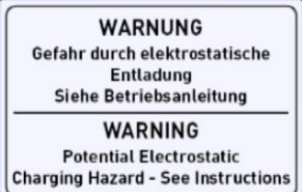
	<p>Die Pumpen MEM 5600 sind mit folgendem Warnschild versehen.</p>
--	--

5.8 Qualifications of personnel

Tasks on the pump must only be performed in accordance with existing rules and statutory regulations, by personnel who have been instructed and who are qualified in this regard, in compliance with due diligence obligations.

The following requirements must be met:

- Personnel must have special skills and experience in the respective technical area. This particularly applies for maintenance and repair tasks on mechanical and pneumatic fixtures of the pump.
- Personnel must be familiar with applicable standards, directives, accident prevention regulations and operating conditions.
- Personnel must have been authorised by the person responsible for safety to perform each of the required activities.
- Personnel must be capable of recognising and avoiding possible dangers.

The required personnel qualifications are subject to different statutory regulations depending on the installation site. The owner must ensure compliance with applicable laws.

5.9 Personal protective equipment

Failure to wear the personal protective equipment can result in severe or fatal injury.

- Wear the operationally prescribed protective equipment, e.g. hearing protection, eye protection, safety footwear, hard hat, protective clothing and protective gloves for all tasks on the pump.



- Long hair must be tied back and covered; do not wear loose clothing or jewellery.
Danger of injury through snagging, being drawn in or entanglement due to moving parts.
- Ensure that there are no unauthorised persons in the danger zone.

5.10 Safety notices in the operating manual

Danger

The signal word **DANGER** indicates a possible danger.
Failure to comply can result in death.

WARNING

The signal word **WARNING** indicates a possible danger.
Failure to comply with the instruction can result in severe or fatal injury.

CAUTION

The signal word **CAUTION** indicates a possible danger.
Failure to comply with the notice can result in minor to moderate injury.

! Attention

The signal word **Attention** indicates possible material damage.
Failure to comply with the notice can result in machine damage.

Environmental protection notice

The signal words **Environmental protection notice** indicate information on environmental protection.

Note

The signal word **Note** indicates additional information for the machine or its use.

5.11 Safety notices

WARNING

Endangerment of people and the machine!

- Operate the pump only if all protective and safety-related devices are in place and functional.
- Immediately eliminate or have eliminated any malfunctions that could impair safety.
- Observe residual risks and dangers.
- Observe the intended use.
- Observe generally recognised safety rules.
- Observe country-specific regulations.
- Observe the manufacturer's instructions (safety data sheets) for operating and auxiliary materials.
- Observe all safety and danger notices on the machine and keep them complete and legible.
- Observe all general and special safety instructions in these assembly and operating instructions and in the operating instructions of the third-party manufacturers.
- Refrain from any unsafe working practices.
- Always keep the assembly and operating instructions within easy reach at the place of use and observe them.
- Stop the machine immediately and report the fault to the responsible office/person if safety-relevant changes have been made or if the operating behaviour of the machine changes.
- Stop the machine immediately and report the fault to the responsible office/person if safety devices are damaged, defective or changed.
- Do not remove or change safety devices and warning signs on the machine. Do not modify machine parts without authorisation. Do not modify the control and switching devices on the machine.

 **WARNING****Danger to people and the machine!**

- Access to the workplaces at the machine is not permitted for unauthorized persons.
- The pump may only be operated with suitable media.
- The pump must be protected from strong sunlight, IR and UV radiation.
- The operating parameters of the compressed air and the media pressure must not be exceeded; safety devices may have to be installed to ensure this.
- Observe the intended use.
- Commissioning and operation of the pump only after it has been determined that the complete system in which the diaphragm pump is to be integrated complies with the Machinery Directive 2006/42 / EC and Directive 2014/34 / EU.

 **CAUTION****Health impairment due to contact with harmful media!**

- If the possibility of contact with the medium cannot be excluded, do not perform cleaning, repair, troubleshooting and fault rectification, until after you have put on the appropriate personal protective equipment PPE (at least protective clothing, protective gloves, protective goggles).
- Comply with the safety data sheets provided by the manufacturers and the national laws and regulations.
- Liquids escaping from the pump must be checked for possible health hazards before contact. Take protective measures if necessary.

Caution

Pump damage due to the operating conditions and properties of the pumped media!

- The characteristics of the pumped media (such as abrasiveness, viscosity, etc.) and the operating conditions can have a negative effect on the service life and the function of the pump.
- Solids in the media can damage the pump, particularly the diaphragms, and cause immediate failure.

Caution

Pump damage due to media that is chemically incompatible!

- The owner of the pump must check whether the pumped media is chemically compatible with the materials that were used to construct the pump.

A list of the materials used in the pump is provided in the "Technical data" section.

Caution

Pump damage due to high mechanical forces!

- Do not subject the pump to strong mechanical forces.

Caution

Destruction of the pump due to excessive supply air pressure!

Excessive supply air pressure can destroy the diaphragms and cause the pump to burst.

- Operate the pump with a maximum supply air pressure of 8 bar.
- Ensure that the exit point of the pumped medium is not clogged or sealed.



Environmental protection notice

Environmental pollution due to pumped media and cleaning agents.

- Regularly check all lines, hoses and connections for leaks and apparent damage. Immediately repair any damage!
- Take up or wipe up leaked and spilled media and cleaning agents and dispose of them in an eco-friendly manner.
- Prevent escaped or spilled media and cleaning agents from getting into the groundwater.
- For safe and eco-friendly disposal of media, cleaning agents and replacement parts.
- Comply with the safety regulations applicable to the media and cleaning agents.

6 Transport

To prevent transport damage, if possible only transport the pump only in its original packaging.

6.1 Check scope of delivery

1. Remove the transport packaging of the pump.
2. Check the fasten seat of all screws on the pumps.
3. Lift the pump with the appropriate lifting equipment.
4. Store the packaging material or dispose it properly.
5. Examine the pump for transport damage.
 - Immediately notify the transport company and the manufacturer of transport damage, in writing.
 - Protect the pump from further damage.
6. Use the delivery note to verify the completeness of the delivery.

6.2 Lifting pump scope of delivery

Attach the lifting accessories such as ropes below the upper bridge.

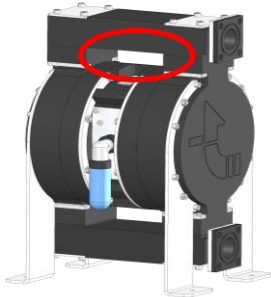

Fig. 1 Implementation (red marked) for lifting accessories



Warning



Danger from mass of the pump!

- Lift the pumps MEM5150, MEM5600 only with lifting equipment and not manually.
- The lifting gear and sling must be designed according to the weight of the pump.
- Mount the lifting gear carefully so that slipping is definitely prevented during the lifting process

7 Additional ATEX information

7.1 ATEX-marking in accordance with directive RL 2014/34/EU und DIN EN ISO 80079-36 for the pump



II 2G Ex h IIB T6-T4 Gb X
II 2D Ex h IIIC 85°C–150°C Db X

Symbol	Meaning
	CE mark.
	Marking relevant for explosion prevention in accordance with ATEX.
II	Atex device of Equipment Category II intended for use in explosive atmospheres, except for mines.
h	CE mark.
2 G/D	ATEX device of Equipment Category 2 (avoidance of effective ignition sources). The device can be used as intended in areas where Zone 1 and Zone 2 explosive gas or dust atmospheres can occur. Use of the device is prohibited in Zone 0.
IIB	The intended use is permitted in gas explosive areas with gases and vapours of explosion groups IIA and IIB. The intended use is not permitted in gas explosive areas with gases and vapours of explosion group IIC.
IIIC	Use as intended in potentially explosive dust atmospheres with dusts of dust groups IIIA, IIIB and IIIC
T6-T4	Temperature class for the gas explosion hazard area. The actual maximum surface temperature does not depend on the device, but on the operating conditions (media temperature and compressed air temperature).
T85°C-T150°C	Surface temperature for the dust explosion hazard area. The actual maximum surface temperature does not depend on the device, but on the operating conditions (media temperature and compressed air temperature).
Gb/Db	Device protection class for gas or dust. In normal operation and for the faults that can usually be expected (defects on the device), the device ensures the required degree of safety and avoidance of ignition sources.
X	The following special conditions must be met to ensure safe operation of the pump in explosive atmospheres. Pay attention to the limited ambient temperature. Observe conductivity of the medium. Observe membrane type. Observe the compressed air outlet. If there is a dusty atmosphere, discharge the exhaust air to a safe, dust-free place.

A yellow triangle with a black border and a black exclamation mark inside, indicating a warning.**WARNING****Danger due to highly effective charge-generating processes!**

- Highly efficient charge-generating processes can cause electrostatically dangerous charging of diaphragms that have a non-dissipative layer (e.g. PTFE) on the media side. Highly-effective processes that generate static charges, include fast pumping of multiphase fluids and liquids with low conductivity ($< 100 \text{ pS/m}$) and the purging of the pump with compressed air.
The owner must take additional protective measures to safely prevent these processes. Possible measures include:
 - Filling the pipes and pump chambers with inert gas during dry-run
 - very slow filling and emptying of the pump when starting the pump in combination with safe avoidance of dry running (shuffling operation).
 - Limit the duration of the priming or draining process to $< 30 \text{ sec}$.
- Highly-effective charge-generating processes can cause electrostatic charging of labels/stickers, silencers and ball valve handles. Highly efficient processes that generates charges include cleaning the pump with a high-pressure cleaner.
The owner must take additional protective measures to safely prevent these processes. Possible measures include:
 - Large-area, permanent covering of the labels/stickers with transparent conductive foil, or the removal of such labels/stickers (rating plates must not be removed).
 - Replacement of the silencer with a conductive/dissipative silencer.
- By spraying liquid through the silencer, the liquid and/or the silencer can get electrostatically charged. This can happen in case of a diaphragm fracture or operating with very humid compressed air. The process depends on used media and parameters. The operator has to rate the risk and if necessary, implement additional protective measures.

 **Danger****Danger due to explosion!**

By using pumps type MEM5600V with not entirely conductive diaphragm materials (for example standard PTFE diaphragm) the diaphragm can get dangerously electrostatically charged during operation of the pump.

- Appropriate measures must be taken to prevent ignitable discharges. appropriate measures can be for example:
 - definite prevention of dry running
 - Inerting during dry running

Prolonged operation of the pump with active residual discharge, corresponding to operation in zone 0.

- Permanent operation of the pump with active residual discharge must be safely prevented.

Danger due to explosion!

It comes to strong chemical reactions when trichloroethane, methylene chloride or solvents (based on halogenated hydrocarbons) come into contact with the aluminium containing components of the pump.

- Do not convey the above-mentioned substances with pumps made of aluminium-containing material.
- Preserve pumps before contact with the medium.

 **Warning****Danger of explosion due to hot surfaces!**

The maximum surface temperature is equal to the max. temperature of the pumped medium and/or the compressed air temperature.

- In accordance with national regulations, the medium temperature/compressed air temperature must with certainty and with a sufficient differential, underrange the ignition temperature of the explosive atmosphere.

7.2 Optional Componenten

The pump can be equipped optional with a stroke counter (see Section 7.3).

The sub-assemblies, pump and stroke counter comply with Directive 2014/34 / EU, this is confirmed by the manufacturer's declarations of conformity. The installation of the sensor was carried out according to the manufacturer's instructions.

The entire assembly was subjected to a risk assessment for the additional ignition hazards and other relevant hazards that become relevant as a result of the final combination.

It was ascertained that the assembly did not change the explosion characteristics of the sub-assemblies with regard to the essential safety and health requirements and that no additional ignition hazards arise.

The complete functional unit is therefore not a device unit that falls within the scope of Directive 2014/34 / EU. The assembly, consisting of sensor and pump, is not to be regarded as a new product within the meaning of the ATEX directive 2014/34 / EU. With regard to explosion protection, it should therefore be viewed as a combination of "individual sub-units". The company Timmer therefore provides the EU declaration of conformity for the sub-units and does not create an overall declaration of conformity.

The ATEX guidelines (ATEX guidelines for Directive 2014/34 / EU, 1st edition from April 2016) in § 44 "Combined components (assemblies)" 2.a) provide detailed information on how to proceed with an assembly group.

7.2.1 Ignition Sources

Hot surfaces, mechanically generated sparks, chemical reactions and static electricity are potential sources of ignition in the pump. By integrating them into the equipotential bonding, restricting operating parameters and setting conditions, the effectiveness of these ignition sources are reliably prevented. The ignition sources of the external suppliers can be found in the respective operating instructions.

7.3 Optional ATEX Component

Warning

Danger due to explosion!

Explosion protection-relevant properties, such as explosion group (gas), temperature class (gas) etc., of sensor and pump differ.

- The labelling and operating instructions of the optional ATEX components and the pump must be observed.

No.	Designation	Manufacturer	Type	Device identification
1	Magnetic proximity sensor	Timmer GmbH	53507437	II 2G Ex ib IIC T4 Gb II 2D Ex ib IIIC T135°C Db -25°C ≤Ta≤+70°C
2	Capacitive sensor	Rechner Sensors	KAS-40-A12-N, ATEX	II 1G Ex ia IIC T1-T6 Da
3	Capacitive sensor	Rechner Sensors	KAS-40-A12-N-StEx, ATEX	II 1G Ex ia IIC T1-T6 Da II 1D Ex ia IIIC T 101°C Da

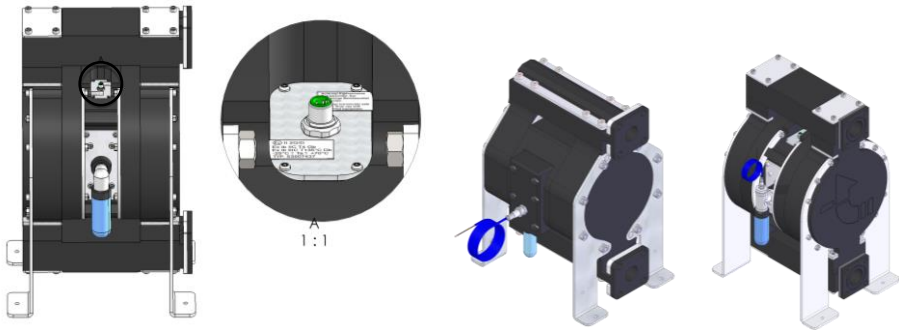

Fig. 2 Example proximity sensor (left) and capacitive sensor (right)

8 Storage

- The storage conditions influence the service life of the diaphragms. Long storage times lead to a reduction in the service life.
- The pump must not be stored for safekeeping unless it has been thoroughly cleaned beforehand.
- Extreme storage conditions accelerate the ageing process.
- We recommend a storage temperature between +10 °C and +25 °C.
- The pump must not be exposed to heat sources or direct sunlight.
- Exclude the possibility of exposure to ozone or ionising radiation.
- Store the diaphragms in tension-free condition.
- We recommend replacing the diaphragms at the latest after one year of storage under the storage conditions cited above.
- The storage conditions for third-party components can be found in their operating instructions.

9 Product description

The double diaphragm pump is a self-priming, pneumatically driven fluid pump. The fluid is conveyed by the opposing movement of two diaphragms. A reversing valve ensures that the two diaphragms are alternately charged with compressed air. Each diaphragm has a fluid inlet valve and a fluid outlet valve. If the pump chamber is enlarged due to movement of the diaphragm, the outlet valve closes and the inlet valve opens so that fluid is suctioned into the pump chamber. When the diaphragm moves in the other direction, the pump chamber becomes smaller, the inlet valve closes, the outlet valve opens and the fluid is pumped out.

When one of the diaphragms reaches its end position in the suction process, the limit switch activates the reversing valve so that the other diaphragm is charged with compressed air.

The reversing valve is designed in such a manner that it cannot remain in a middle position.

For observation the pump strokes, a magnet can be attached to one end of the main valve rod. With an optional magnetic field sensor (installed in the middle part) the reduced or enlarged field due to distance change can be measured.

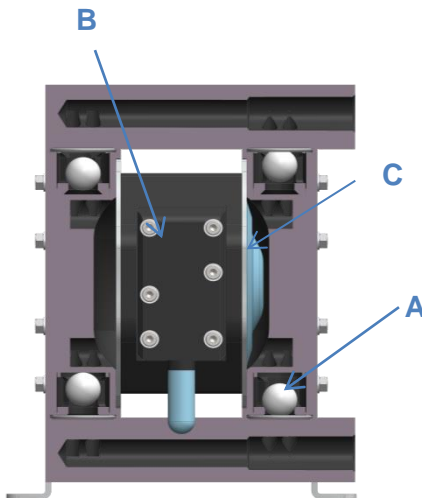

Symbol	Meaning
A	Valve ball
B	Control Valve
C	Diaphragm

Fig 3 Section pump

Product description

9.1 Product description: Pump

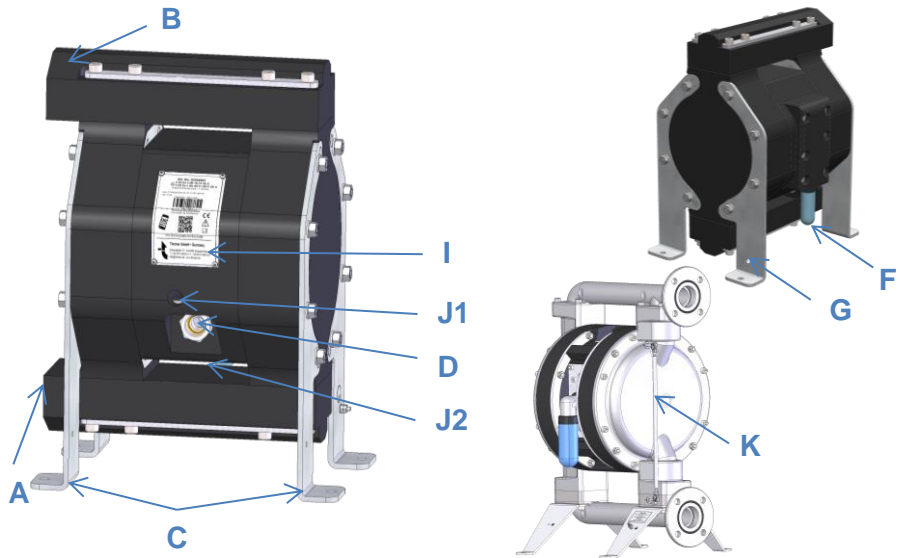

Fig. 4 Pump

Symbol	Meaning
A	Media entrance
B	Media outlet
C	Feet with mounting holes
D	Compressed air connection including coarse filter
E	Connection and labeling of stroke counter (optional, not shown)
F	Compressed air outlet / silencer
G	Equipotential bonding connection
H	Flange reinforcement (optional, not shown)
I	Type label
J1/J2	Vent hole of control valve (J1: MEM 5150; J2: MEM 5060, M5600)
K	Residual emptying at the valve (optional)

Product description

9.2 Product description: Options

9.2.1 Diaphragm fracture identification

A capacitive sensor can be installed optionally in the exhaust air of the pump to detect leaking liquid in case of diaphragm fracture. Assembly and installation instructions can be found in the documents enclosed with the sensor.

The diaphragm fracture identification does not prevent liquid from escaping at the silencer.

Condensation in the air circuit can lead to false alarm.

9.2.2 Emptying of residues

! Caution

Damage of the membrane if emptying of residues and pump are used at the same time!

- Do not activate residual emptying while the pump is running.

Pumps with emptying of residues have an integrated manual operated plunger in each valve seat. The plunger on one side of the diaphragm are coupled to one another by a rod. By actuating the plunger by moving the rod, the valve balls are permanently lifted out of their seat. This means that any remaining quantities in the pump or the pipe system can flow back into the tank.

Operation emptying of residues:

Before using the residual drain, switch off the pump.

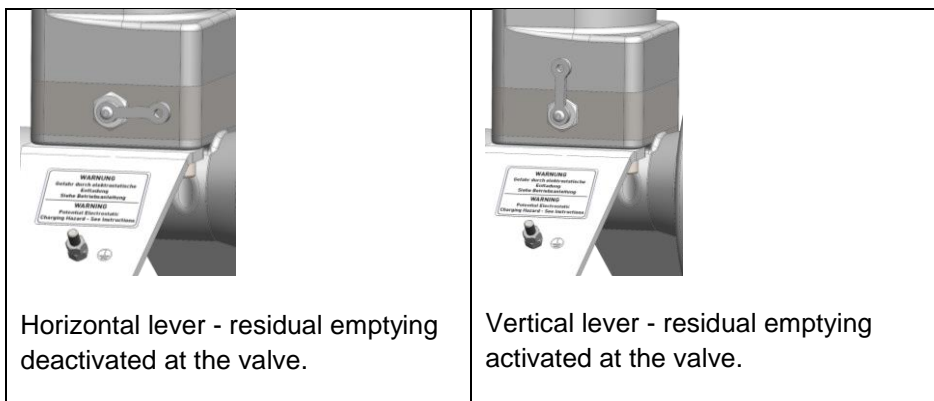

10 Installation

10.1 Safety notices

WARNING

Personnel are in danger due to improper installation!

- Installation tasks must only be executed by trained personnel.
 - Wear personal protective equipment (PPE).
 - The operation of diaphragm pumps with negative suction depends on following factors:
 - Viscosity and specific gravity of the liquid.
 - Length and diameter of the suction hose.
 - Install the pump as close as possible to the sampling point.
 - For the connection lines to the pump, use hoses with rigid spiral reinforcement whose diameter must not be smaller than the pump connection.
 - Use hoses with rigid spiral reinforcement for the connection lines to the pump. The hose diameter must not be smaller than the connection diameter of the pump.
 - Filters and other devices installed on the suction line of the pump must be designed accordingly so a drop in load is avoided. Failure to comply may result in premature diaphragm fracture.
 - The pump must be protected from vibrations / impacts which could damage it and / or which could impair its operation.
-

 **WARNING****Danger of explosion due to electrostatic charging!**

- Before commissioning, connect the pump to the protective earth system (equipotential bonding).
- The pump is not connected to the protective earthing system during installation. There is a risk of electrostatic charging.
- During installation and dismantling, maintenance, transport to/from the place of use, and maintenance there is danger of generating sparks through friction, impact and rubbing processes or through electrostatic charging. Consequently, ensure that these hazards are safely eliminated or that an explosive atmosphere is not present during these work stages.

 **WARNING****Personnel are in danger due to improper installation!**

- By negative suction operation and conveying highly viscous liquids, especially on the suction side, use pipes with an enlarged diameter.
- Connections must be used that are made of material that is compatible with the pumped medium and with the material of the pump.
- The pump does not have its own pneumatic shut-off valve. If the pump cannot be switched off by simply, safely disconnecting or switching off the compressed air supply, an additional, easily accessible shut-off valve must be installed upstream of the compressed air connection.
- The pump must be integrated in the compressed air system in such a manner that it can be taken out of service by switching off the compressed air.
- The compressed air supply (hoses, etc.) must be installed in such a manner that they do not pose any hazard.
- Use a pressure relief valve in the compressed air supply if there is a risk of exceeding the operating parameters.

 **WARNING****Take the following general precautions when installing and using in a potentially explosive environment!**

- During installation and dismantling, maintenance, transport to/from the place of use, and maintenance there is danger of generating sparks through friction, impact and rubbing processes or through electrostatic charging. Consequently, ensure that these hazards are safely eliminated or that an explosive atmosphere is not present during these work stages.
- The medium to be conveyed must be free of harmful solids. If this cannot be guaranteed, suitable filters must be used.
- The pump inlet or outlet must not be narrowed to prevent cavitation or overloading of the pump.
- The connecting pipes must be resistant and must not be deformed by the weight of the pump and the suction volume. The weight of the lines must not put a strain on the pump connections.
- The setting must be protected from squirting liquid in unforeseen pump malfunctions.
- The pump must be always protected from any vehicles that may collide with it or other vibrations / impacts which could damage it and / or which could impair its operation.
- If there is no or incorrect equipotential bonding, the safety and explosion protection is not guaranteed.
- The equipotential bonding cable must be selected carefully so that the potential freedom is given on the ATEX components under the ambient conditions.
- The electrical components must be installed by a qualified electrician with established knowledge of explosion protection in accordance with the information provided by the manufacturer of the components.

 **WARNING****When handling dangerous substances:**

The following instructions must be complied with if the hazard analysis conducted by the owner reveals that a possible leak of the medium poses an increased risk:

- The installation of media shut-off valves at the medium inlets and outlets to shut off the medium flow in case of a leakage on the pump.
- The installation of the pump with shut-off valve, 3-way valve and check valve in the compressed air supply line. These 3 components prevent the pumped medium from entering the compressed air system if a diaphragm tears.
- If diaphragms are completely defective, the fluid can enter the compressed air circuit, damage the compressed air circuit and exit via the silencer. Depending on the pumped medium, the silencer must be replaced by a suitable pipe or hose connection to avoid danger. The discharge must be taken to safe place.
- If diaphragms are completely defective, the medium to be pumped can react with materials in the compressed air circuit. Prior to commissioning the owner must assess the risk and take suitable measures. The corresponding pump materials are given in chap. 17.

 **Caution****Personnel are in danger due to inadequate lighting!**

- Only perform installation tasks on the pump in an adequately illuminated and air-conditioned environment.

Caution**Fault or damage due to residual substances in the pump**

- Prior to commissioning, purge the pump with suitable media to remove from the pump interior any substances introduced during the customer process (goods receipt, handling, storage, installation, etc.) that are detrimental to paint adhesion, or substances that are incompatible with the pumped medium.
- For this, strictly comply with the instructions in section 14.5 Cleaning.

Preparations

- Do not use the pump as a support for the piping system.
- Ensure that the system components are properly supported to prevent weight load on the pump parts.
- Ensure that the regulations regarding the protective earth system (equipotential bonding) are complied with.
- During installation and dismantling, maintenance, transport to/from the place of use, and maintenance there is danger of generating sparks through friction, impact and rubbing processes or through electrostatic charging. Consequently, ensure that these hazards are safely eliminated or that an explosive atmosphere is not present during these work stages.
- If necessary, a shut-off valve for the medium to be pumped must be installed at the pump inlets and outlet.
- If necessary, a shut-off valve, a compressed air preparation system, a non-return valve, pressure regulator and pressure relief valve must be installed for the compressed air supply to the pumps. A pressure regulator is necessary to adjust the delivery rate of the pump.
- If necessary, the vent (silencer) of the compressed air must be moved to another location using suitable hose material.

10.2 Pump assembly

1. Mount the pump on a horizontal and level surface with the pump feet facing down. If the pump has not been mounted on a horizontal and level surface with the pump feet facing downwards, the function of the media check valves is not given. Do not immerse the pump in the medium to be pumped.
2. Ensure that the pump stands securely by fixing the foot to the 4 holes provided with suitable fixing screws.

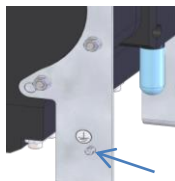

Fig. 5 Earth connection

3. Connect the pump to a protective earth system. Use the earth connection shown in Fig. 5 for this purpose.

Installation

4. Tighten the screws as described in chap.14.4 Tightening torques.
5. If necessary, install the emergency shut-off valves at the medium inlets and outlets with a diameter greater than or equal to the pump connection diameter.
6. If necessary, install the appropriate clamp to attach the hoses to the pumps or valve outlets.
7. Install the suction and supply lines to the appropriate connectors or directly to the pump. Install the suction and supply lines to the appropriate connectors or directly to the pump. Please note the pin assignments shown in Fig. 4 and the information given in Chapter 10.2.2 Laying the connection line.
8. If necessary, install the compressed air preparation system, a check valve, pressure regulator and pressure relief valve for the compressed air supply.
9. Install the compressed air connection.
10. Check all connections for tight fit and tightness.

10.2.1 Connection Options

Version 1:

Connection via the internal thread of the connecting piece.

Suitable sealants must be used to seal the connection.

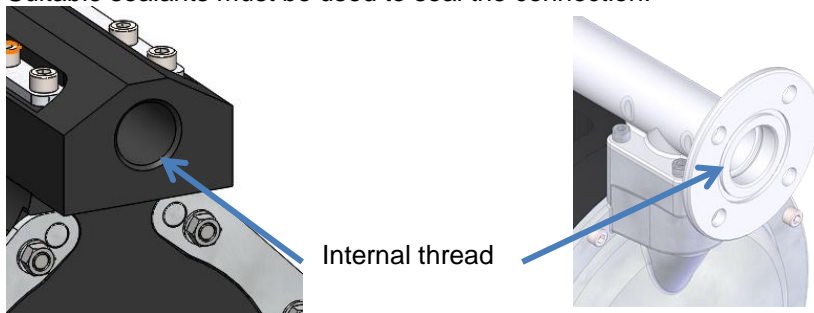
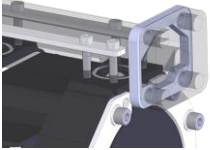

Fig. 6 Connection via internal thread

Variant 2

Connection via flange. When connecting via the flange surface, two flange reinforcements must be used for each connection. A suitable sealing ring must be installed between the pump flange and the pipe flange by the installer.

MEM 5060



MEM 5150

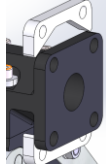

MEM 5600

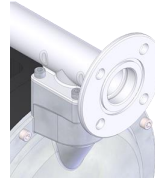
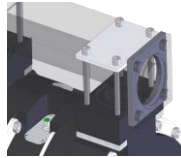

Installation position of the flange

Fig. 7 Connection flange

10.2.2 Laying the connection line

Avoid fitting any additional device on the suction side of the pump (connections, elbows, valves, filters, etc.) that could affect the suction conditions of the pump and cause premature rupture of the diaphragms, except stop valve that can be used to isolate the pump in the event of a fault.

Support the pipes in a suitable manner. The hoses must be sufficiently resistant to deformation on the suction side.

When used for priming from drums, the pump must always be positioned above the drum. Furthermore, a bevelled pipe end must be used to prevent the suction line from being sucked into the bottom of the barrel.

The compressed air supply for the pump must be selected in accordance with chapter 17.

When operating several pumps on only one compressed air supply, mutual interference may occur.

Pressures outside the specifications can lead to malfunctions.

The specifications for volume flow and pressure of the connection lines, accessories, control and adjustment parts must be adapted to the performance of the pump in order to prevent performance losses.

11 Commissioning

11.1 Safety notices

WARNING

Danger of explosion due to dust on the pump housing!

- Regularly clean the surface of the pump housing and remove the layers of dust.
-

WARNING

Life-threatening danger due to pumping explosive media in hazardous areas!

- Pumping of explosive media or gases is prohibited.
 - The medium to be pumped can corrode or otherwise damage components of the pump and escape. This can result in an explosive mixture.
-

WARNING

Danger to life from pumping aggressive, poisonous or harmful liquids.

- In case of material failure, e.g. rupture of the diaphragm, the pumped media can escape from the pump. Suitable protection must be installed on the pump to shield and catch the escaping medium.
 - The medium to be pumped can attack or destroy components of the pump and escape. This can result in an explosive mixture outside the pump.
-

 A yellow triangle with a black border and a black exclamation mark inside.**WARNING****Life-threatening danger when operating the pump in hazardous areas!**

- The pump may only be used in potentially explosive atmospheres (e.g. paint shops) if the Atex marking on the pump rating and its sub-assemblies meet the requirements of the zone classification.
- During operation, ensure that the pump is always completely filled with fluid. The continuous pumping of ignitable gas/fluid mixtures that cause a Zone 0 to occur inside the pump, is prohibited.
- Moreover, the owner of the pump is obligated to comply with the requirements stipulated in Directive 1999/92/EC.
- The pumped medium can react exothermally with the material of the pump. Before pumping the medium, check the suitability of the pump materials for the medium to be pumped.
- Operation of the pump above the permissible flow rate and longer dry-run operation can cause overheating of the pump.
- When pumping media in ring systems, the delivery capacity of the pump is converted into heat. For short lines, this can cause dangerous heating of the medium.
- Operation of the pump can adiabatically compress explosive gas mixtures in the pump and/or the piping system. This can result in increases in temperature that pose an ignition hazard. The owner must take appropriate measures. The media outlet must not be closed during pump operation.

Caution

Destruction of the pump due to excessive supply air pressure!

Excessive supply air pressure can destroy the diaphragms and cause the pump to burst.

- **ATTENTION:** The supply air pressure must never exceed 7 bar.
- Ensure that the exit point of the pumped medium is not clogged or sealed.

1. Check all connections for correct installation.
2. Tighten the screws with the torque specified in chapter **Fehler! Verweisquelle konnte nicht gefunden werden..**
3. Open the valves at the media inlets and outlets.
4. Set the compressed air to a pressure of 1 bar.
5. Open the ball valve for the compressed air supply. The pump starts automatically.
6. Check all connections for leaks.
7. Increase the pressure of the compressed air or the frequency of the valve until the desired volume flow is reached.
8. Check all connections for tightness.

12 Operation

► Note

Retighten all screws mentioned in chap. 14.4 Tightening torques with the appropriate torques, after the first hours of operation.

12.1 Switch on

1. Check all connections for correct installation.
2. Open the valves at the media inlets and outlets.
3. Set the compressed air to the desired value.
4. Open the ball valve for the compressed air supply. The pump starts automatically.
5. The pump frequency and delivery rate adjust themselves depending on the medium, installation situation and setting of the compressed air.

12.2 Regulating the delivery rate

► Note

If the delivery rate of the pump must be regulated, the owner must install a throttle valve in the compressed air supply or in the delivery line

Reduce the delivery rate

- Reduce the compressed air supply or the medium outflow.

Increase the delivery rate

- Increase the compressed air supply or the medium outflow.

12.3 Switch off

1. Close the compressed air supply.
2. If necessary, close the valves on the media inlets and outlets.

13 Fault rectification

Fault	Fault cause	How to eliminate the fault
Pump does not run or it runs too slow	Insufficient compressed air pressure	Set pressure between 4 and 8 bar
	The hose cross-section is too small	Use a hose with a larger cross-section
	Control valve leaks	Replace distributor valve and seals
	Clogging of the silencer, pump does not run smoothly, seal is swollen or piston material is damaged	Check material resistance, avoid dry run
Pump runs but does not pump any medium, or does not stop when the pressure side is shut off	Valves contaminated	Flush the pump with cleaning agent
	Delivery hose is clogged	Clean delivery hose
	Suction and pressure valves are contaminated	Let the pump run for 10 to 20 minutes at top speed
	Connections leak, possible intake of external air, vacuum collapses	Check connections for leaks; re-seal
	Valves contaminated	Clean or replace the valves
	No suction effect on the suction-side and pressure-side	Close openings with your hands to check the suction effect and, if necessary, replace the seals
	Excessive viscosity of the pumped medium	High-viscosity media cannot be pumped (see section "Technical data" for the limit values)
	Delivery hose has cracks or holes	Replace delivery hose

Fault	Fault cause	How to eliminate the fault
	Excessive counterpressure at the injection point	Reduce counterpressure at the injection point
	Threaded fittings, ball valve or non-return valve either have no passage or reduced passage	Restore passage: Clean or replace the components
	Air in the pump chamber	Vent the pump
Fluid container runs empty autonomously	Exit point of the fluid is lower than the fluid level in the container	Place the fluid container lower or position the exit point higher

14 Maintenance /Cleaning

14.1 Safety notices

WARNING

During maintenance, observe the general precautions for installation and use in potentially explosive environments!

Observe the safety instructions in chapter 10.1.

WARNING

Personnel are in danger due to improper installation!

- Installation tasks must only be executed by trained personnel.
- Wear personal protective equipment (PPE).
- Only use original spare parts.

 **WARNING****Hazard for personnel due to spraying fluids (media)!**

- Ensure that the material hoses and other components can withstand the fluid pressure generated by this pump.
- Regularly check the pump for damage or wear.
- Ensure that the pneumatic valve, the outlet area for the compressed air and the suction side and pressure side for the medium are clean and function effectively.
- Depressurise the pump before dismantling. Under some circumstances there can still be a low residual pressure in the pressure chamber that causes medium to spray out.
- Before any dismantling tasks on the pump, comply with the safety data sheets provided for the previously pumped chemicals.

 **WARNING****Hazard for personnel due to trapped compressed air and pressurised medium!**

- Do not service or clean the pump, hoses and the outlet valve for the compressed air while the system is pressurised.
- Before performing tasks on the pump de-pressurise the pneumatic section and the fluid section.
- Shut off the compressed air supply and wait until the residual pressure is dissipated via the outlet valve for the compressed air.
- Empty the pump before replacing components.

⚠ Caution**Personnel are in danger due to inadequate lighting!**

- Only perform installation tasks on the pump in an adequately illuminated and air-conditioned environment.

Health impairment due to contact with harmful media!

If the possibility of contact with the medium cannot be excluded, do not perform cleaning, repair, troubleshooting and fault rectification, until after you have put on the appropriate personal protective equipment PPE (at least protective clothing, protective gloves, protective goggles).

- Comply with the safety data sheets provided by the manufacturers and the national laws and regulations.

14.2 General**Caution!**

Spare parts for the non wetted parts cannot be exchanged. Spare parts for these components are not available.

The pump is wear-resistant except for the diaphragm. The quality of the compressed air supply, the properties of the pumped media (such as abrasiveness, viscosity, etc.) and the operating conditions can have a negative effect on the service life of the pump.

Therefore, we recommend a regular check of the pump and the pneumatic valve.

However, should a malfunction occur or the pumping capacity decrease, you can carry out the following work:

- Replace the diaphragms.
- Clean the media check valves.

14.3 Maintenance schedule

Create a maintenance plan based on the operating time of the pump. Such a maintenance plan with maintenance intervals is particularly important in order to keep the pump working properly.

The following table contains recommendations. If the pump is under great strain from the medium or the ambient conditions, shorter maintenance and replacement intervals must be used.

Machine part	Work to be carried out	Interval
Pump total	Check the proper condition and cleanliness of the machine.	for each shift
Pump external parts*	Check the pump housing for discolouration and cracking.	monthly
Pump Screws Outer	Tighten all screws regularly according to chapter 14.4.	Recommended: monthly
Diaphragm**	Check diaphragm	
Diaphragm	Replace diaphragm	Recommended: at least after 5 million double strokes
Pump inner parts*	Checking the plastic parts for discolouration and cracking	Recommended: at least after 20 million double strokes

*The physical properties of the plastic components can change through contact with unsuitable liquids, strong heat or UV radiation. This process can take place very slowly. Regular inspection of the components is therefore necessary. If the colour changes or cracks form, the entire pump must be replaced.

**The membranes (in contact with the product as well as outside) are wearing parts. The durability depends to a large extent on the conditions of use, as well as on the chemical and physical stress.

14.4 Tightening torques

Plastics tend to settle under stress. As a result, the screws lose their pre-tension, which can lead to leaks in the pump. For this reason, the marked screws on the bridges, valve covers and pump covers as well as the threaded rods must be tightened or checked at regular intervals in accordance with the table. The intervals are to be determined by the operator. Strong temperature fluctuations or temperature differences in the medium, the compressed air and the environment may require shorter intervals. The tightening torque must be checked and tightened more frequently within the first operating hours and days.

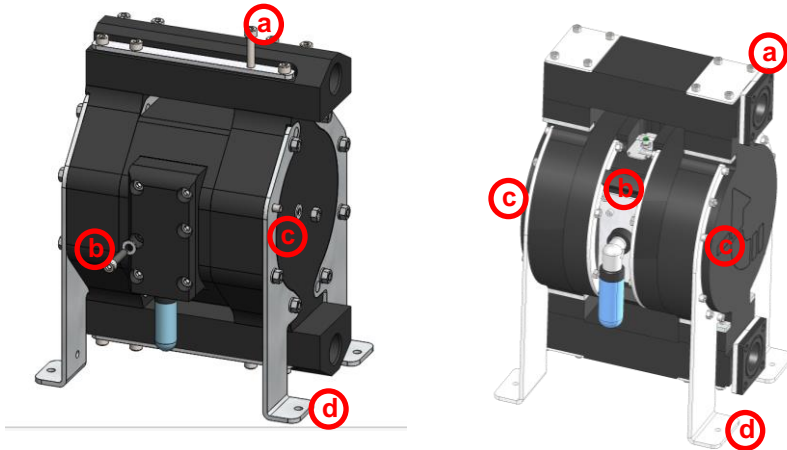

		Tightening Torques				
		a	b	c	d	Flange connection
Pump type	MEM 5060	8 Nm [16 pcs.]	1,5 Nm [6 pcs.]	12 Nm [8 pcs.]	To be determined by the operator.. [4 pcs.]	To be determined by the operator. [8 pcs.]
	MEM 5150	15 Nm [16 pcs.]	2 Nm [6 pcs.]	15 Nm [8 pcs.]		
	MEM 5600	25 Nm [16 pcs.]	8 Nm [4 pcs.]	25 Nm [20 pcs.]		

14.5 Cleaning **WARNING****Danger to persons due to chemical reaction!**

- The cleaning agent used must be selected in such a way that there is no chemical reaction with the pump material or the previously pumped medium.
 - The cleaning agent used must be selected in such a way that it does not change the mechanical properties of the pump.
-

1. Only clean the pump with a cleaning agent that is suitable for the pump material and the pumped medium.
Liquid and solid cleaning agents must not exceed a temperature of 60 °C.
2. Pump the cleaning agent until all residues in the pump are detached.
3. Completely empty the pump.
4. Clean the outer parts of the pump

Cleaning before decommissioning

1. Clean and empty the pump as described in the previous paragraph.
2. Replace the pump diaphragm at the latest after one year of storage, as it is subject to normal aging and to ensure safe and reliable operation of the pump.

Extreme storage conditions can accelerate the aging process.

 **Note**

In the event of decommissioning and storage, a complete emptying of the pump is necessary, as the cleaning liquid may accelerate the aging of the pump diaphragm.

14.6 Timmer-Service

We recommend that all maintenance work, in particular on the entire pneumatic unit, be carried out by the Timmer service.

Timmer offers a comprehensive service concept for this purpose.

14.7 Replacement of components

Caution!

The replacement of components may only be carried out by trained personnel

Carry out of the measures before the exchange

- Put on suitable personal protective equipment (face mask, gloves, safety shoes, aprons, etc.)
- Drain the fluid from the pump
- Flush the inside of the pump with a suitable, non-flammable liquid agent
- Shut off the air supply with the appropriate valve and make sure that there is no residual pressure in the pump
- Close the manually medium valves (suction and discharge)
- Disconnect the air supply from the mains
- Put on suitable personal protective equipment (face mask, gloves, safety shoes, aprons, etc.)
- Dismantle the pump from its installation location and dismantle the pump at a suitable location.

14.7.1 Replacement and cleaning of the compressed air filter

Unscrew the compressed air filter



2

Clean the filter or replace the filter basket.

Reseal the screw-in thread with sealing tape. Caution: Only cover the area marked in blue with sealing tape, the first thread turns must remain free of the sealing tape.

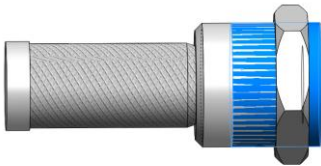

3

Screw the compressed air filter back into the pump and perform a leak test of the compressed air.

4

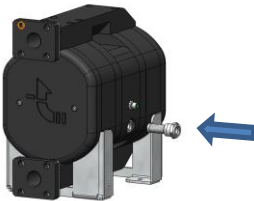
 **WARNING****Endangerment of persons by explosion**

- Correct protective earth system (equipotential bonding) of the compressed air filter only given if the first threads are free of sealing material. If necessary, an electrical resistance measurement must be carried out between the pump housing and the compressed air filter.

Caution

Parts that do not come into contact with the medium may not be designed for chemical resistance to the medium to be conveyed. If these parts come into contact with the medium in the event of a membrane fracture or during maintenance, they can be permanently damaged. Before this intervention, all external surfaces of the pump must be cleaned with a moist cloth!

MEM 5060 /
MEM 5150

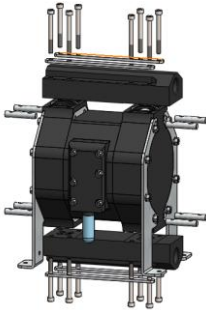

1

MEM 5600



Remove the two bridges by loosening the screws and threaded bolts shown

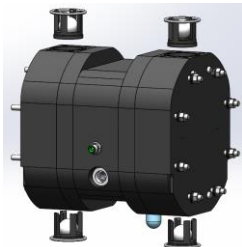

2



Remove the 4 valve balls including the basket and seal

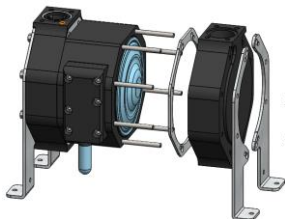

3



Loosen the threaded rods by removing the corresponding nuts.
Caution: This means that all housing parts lose their connection to one another.

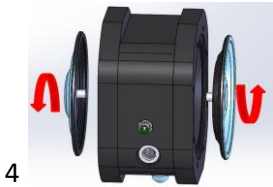

Remove the membrane by turning the membrane in the opposite direction.

Use the torques from chap. 14.4.

The assembly is carried out in reverse order.

Please note the following for pump type MEM5600:

Manually turning the membrane inside out leads to permanent damage; compressed air is required for installation.

Execution:

1. Screw both diaphragms hand-tight onto the piston rod.
2. To fix the assembly, pressurize the ventilation hole (1/8 ") with compressed air (max. 3 bar).
3. Connect the compressed air connection (3/4 ") to the compressed air via a pressure regulator. Pre-setting 0 bar!
4. Increase the pressure until you can see which membrane chamber is active (air is escaping). Reduce pressure to zero again.
5. Mount the side part on the active chamber side only with the 8 screws and nuts. Adhere to the torque!
6. Slowly increase the pressure until the exposed membrane has reached the end position (max. Pressure 0.5 bar!). Leave pressure applied!
7. Mount the side part on the inactive chamber with the 8 screws and nuts. Adhere to the torque!
8. Push in the 4 tie rods and fix them with the 8 nuts. Adhere to the torque!
9. Tighten screws / nuts repeatedly with torque
10. Remove the pressure regulator from the exhaust air hole and let the pump switch over several times.

15 Decommissioning

15.1 Safety notice

WARNING

Take the following general precautions when mounting and using in potentially explosive environments!

Observe the safety instructions from chapter 10.1.

WARNING

Personnel are in danger due to improper installation!

- Installation tasks must only be executed by trained personnel.
- Wear personal protective equipment (PPE).
- If the pump is to be out of service for a long time, clean it carefully: flush with a non-flammable liquid detergent compatible with the pump's construction materials.
- If the pump has been out of service for a long time, flush it with clean water for a few minutes to remove any deposits.

CAUTION

Health impairment due to contact with harmful media!

- If the possibility of contact with the medium cannot be excluded, do not perform cleaning, repair, troubleshooting and fault rectification, until after you have put on the appropriate personal protective equipment PPE (at least protective clothing, protective gloves, protective goggles).
- Comply with the safety data sheets provided by the manufacturers and the national laws and regulations.

Decommissioning

Shut off the compressed air supply to the pump if the system will not be in operation for a long time.

Carry out the measures before disassembly

- Drain the pumped conveying medium from the pump.
- Flush the inside of the pump with a suitable, non-flammable liquid agent.
- Interrupt the air supply with the appropriate valve and ensure that there is no residual pressure in the pump.
- Close the hand-operated medium valves (suction and outlet).
- Disconnect the air supply from the mains.
- Wait at least 15 minutes for the pump to cool down.
- Before the procedure, put on appropriate personal protective equipment (face protection, gloves, safety shoes, aprons, etc.)

16 Disposal

16.1 Return shipment

Please send the pump to the following address:

Timmer GmbH

Dieselstrasse 37

48485 Neuenkirchen, Germany

Germany

 **Note**

- Please send the pump in the original packaging, to avoid transport damage.
- The pump must be flushed and the surface must be clean.
- The decontamination certificate must be filled out and enclosed with the pump.
- Always include a safety data sheet of the last pumped medium or cleaning agent with the returned pump.

17 Technical data diaphragm pump

Pump type	MEM 5060	MEM 5150	MEM 5600
Drive	Pneumatic		
Compression ratio	Approx.. 1 : 1		
Working pressure (compressed air)	7 bar		
Max. operation pressure (medium pressure):			
Output side	7 bar		
Input side	max. 1 bar		
Permissible ambient temperature:			
In potentially explosive atmospheres:	+0 ... +40°C		
In non-potentially explosive atmospheres:	+0 ... +40°C		
relative humidity:	80%		
Temperature of the pumped medium:	Temperature is limited by the temperature limit of the components in contact with the medium. **		
Compressed air connection (BSP)	G 3/8"	G 1/2"	G 3/4"
Liquid connections	s. Chap. (10.2.1)		
internal thread (BSP)	G 3/4"	G 1"	G 2"
flange acc. to DIN EN 1092-4 PN 10	DN 15	DN 25	DN 50
	Other connections on request		
weight:	bis zu 8 kg	bis zu 27 kg	bis zu 105 kg
Maximum delivery rate *	60 l/min	150 l/min	600 l/min
Max. frequency (Hz)	7	7	2
Suction head, dry*	2 m	4 m	6 m
Maximum viscosity of the conveyed medium	10.000 mPas		
Max. solid grain size (mm)	4	5,5	10
Max. Sound power level L_{WA} [dB(A)]***	76 - 95	72 - 95	65 - 95
Max. Noise level L_{pA} 1m [dB(A)]***	62 - 81	68 - 82	60 - 82

* Determined at max. operating pressure and water as medium.

** For pump type MEM 5600 with intelligent sensor, the medium temperature is limited to the operating temperature of the intelligent sensor.

*** Determined at 3 or 6 bar. Operating pressure and water as medium. For other operating parameters and media, the values can vary greatly.

17.1 Type Code

! Caution

The materials used in pumps that have been distributed, modified or maintained by the operator or third parties may differ from the type code.

Type Code													
	Series	Type	Design	Max. delivery rate (l/min)	material*								
					medium touched							Midsection	Other
					valve	Side /bridge	Membrane	Ball	Seat	O-ring			
Sample pump:	PTI	MEM	5	150	V	PE1	TF	TF	PE	FKM	PE1	SO	

Material specification type code			
	Material: Side panel / Bridge / Middle section / Ball / Seat		Temperature Limit range
Side panel / seat bridge / ball middle part /	PE1	Polyethylene (PE) black conductive	+5 °C + 70 °C
	PE5	PE white	
	TFE	Polytetrafluoroethylene (PTFE) black	+5 °C + 120 °C
	TF	PTFE white	
	VA	stainless steel	
	AL	Aluminium	
	EP	EPDM	
Valve seal / O-ring	FKM	Fluororubber	+5 °C + 120 °C
	FEP	Fluoroethylene propylene	
	EPDM	Ethylene-propylene-dien rubbers (EPDM)	
	FEPM	Propylene rubber	
	NBR	Acrylonitrile butadiene rubber (NBR)	
Membrane	TF	PTFE composite*	+5 °C + 70 °C
	TA	PTFE composite dissipative*	
	EP	EPDM dissipative	
	TH	PTFE composite*	+5 °C + 120 °C
	TB	PTFE* composite dissipative*	
	EPH	EPDM dissipative	

*Composite diaphragm: PTFE media side, NBR or EPDM compressed air side

Specification Miscellaneous	
iHz	Intelligent stroke counting
FL	flange
SO	Custom-made
SME	Sensor for membrane fracture monitoring
RE	Residual emptying

17.2 Material

Material of wetted parts (standard)
The materials used can be found in the type code on the pump type plate.

Material of wetted parts: Option Residual emptying	
Plastic:	FEP, FKM, EPDM
Metal:	stainless steel
Adhesive:	

Material of non-wetted parts	
Plastic:	PA 6.6, Gummi, NBR, PUR, PETP; POM, PE, EPDM, FKM, FEPM
Metals:	steel/aluminium; Nickel-plated brass, brass
Ceramic:	Aluminium oxide

18 Spare Parts

▶ Notes

Spare parts numbers and extended service information must be obtained from the manufacturer.



Timmer GmbH
Dieselstraße 37
D-48485 Neuenkirchen
Germany

Tel.: +49 5973 9493-0
Fax: +49 5973 9493-90
info@timmer.de

www.timmer.de